

# MNB-01

## USER MANUAL

V1.1

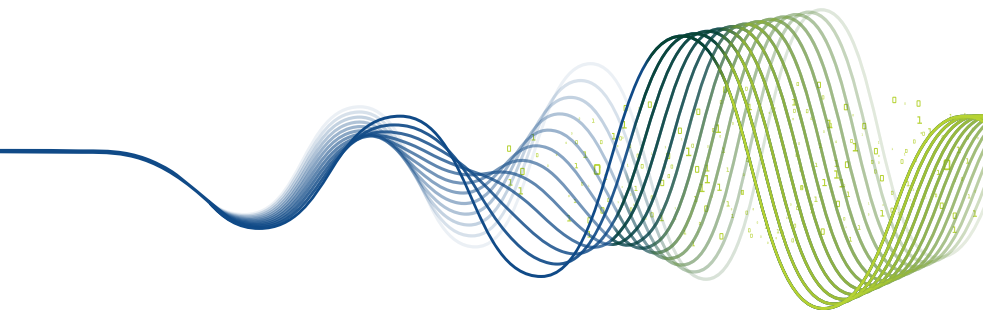

Note: MNB-01 is the product model number and the brand name may vary in different regions. In some countries, the model MNB-01 is branded as the Thuraya MarineStar.



# TABLE OF CONTENTS

## REGULATORY INFORMATION ... 3

EC Declaration of Conformity.....	3
Safety Summary.....	3
Antenna Radiation Warning.....	3
Service.....	4
Grounding and Antenna Cables .....	4
Ship's Power Supply.....	4
Equipment Ventilation .....	4
Obtaining License/Approval for using Thuraya MNB-01 .....	5
Copyright .....	5
Trademarks.....	5

## INTRODUCTION ..... 6

Key Highlights.....	6
Features.....	7
Base Terminal .....	7
Antenna Unit .....	7
Recommended cable lengths for active antenna .....	8
SAT & GPS Cables .....	8
Operating Environment.....	8
General specifications .....	9
Service.....	9
GPS specifications.....	9
Mechanical specifications .....	10
Compliance .....	10
Packing list .....	11
Base Terminal .....	12
Introduction of Ports .....	12
Antenna Unit .....	15

## INSTALLATION ..... 16

Unpacking BDU.....	16
Installation of Base Terminal .....	17
Unpacking ADU .....	18
Radiation hazard.....	18
Interference .....	19
Installation of Antenna Unit.....	20
GETTING STARTED .....	23
Installing the SIM card.....	23
Power up the MNB-01 .....	23
Basic Terminal Set Up .....	24

## USING THE MNB-01 ..... 25

Keypad- Description and Functions.....	25
The Home Screen .....	27
Status Indicators .....	28
Making / End a Voice Call.....	29
Receiving a call.....	29
Adjusting volume during a call.....	29
Using the Main Menu .....	30
Menu Flow schematic .....	30
Messages .....	34
Contacts .....	40
Call logs .....	43
Organizer .....	45
Clock.....	47
Sounds.....	49
Network.....	50
Security.....	52
Settings.....	58
Navigation.....	62
SOS .....	63
Location.....	65

## **QUICK START GUIDE ..... 70**

USING THE MNB-01 .....	70
GETTING STARTED .....	71
Installing the SIM card.....	71
Power up the MNB-01 .....	71
Basic Terminal Set Up .....	72
Making / End a Voice Call .....	72
Receiving a call.....	73
Adjusting volume during a call .....	73

## **TROUBLESHOOTING ..... 74**

Warnings .....	74
Servicing.....	74
Antenna and RF cables .....	74
General .....	74
Care and Maintenance.....	74

## **FAQ ..... 75**

## **WARRANTY..... 78**

## EC Declaration of Conformity

Asia Pacific Satellite Inc., hereafter referred as APSI, be seated on Floor 9, 2-Dong 98, GasanDigital 2-Ro, GuemCheon-Gu, Seoul, 08506, South Korea declares under our sole responsibility that the Product model: MNB-01, is a voice/SMS/GmPRS satellite terminal with a built in GPS tracking system, to which this declaration relates, is in conformity with the following standards and/or other normative documents:

**IEC 60945 and IEC 62368**



### WARNING

This equipment shall not operate when mains power is lost.

## Safety Summary

For the sake of safety and protection, please read the user guide before you attempt to use the Thuraya MNB-01 system. In particular, read this safety section carefully. Keep this safety information where you can refer to it if necessary.

The following general safety precautions must be observed during all phases of operation, service and repair of this equipment. Failure to comply with these precautions or with specific warnings elsewhere in this user guide violates safety standards of design, manufacture and intended use of the equipment.

APSI assumes no liability for the customer's failure to comply with these requirements.

## Antenna Radiation Warning

During transmission, the antenna in the system radiates high power levels of radio frequency. This radiation is considered as a health hazardous to any personnel that comes very close to the antenna.

It is important to maintain a separation distance from the transmitting antenna to any personnel of at least 40 cm.

## Service

User access to the interior of the terminal is not allowed. Only qualified personnel authorized by the manufacturer may perform service. Failure to comply with this will result in the warranty being void.

## Grounding and Antenna Cables

The terminal has a grounding stud to ground the terminal to the hull of the ship by using a ground cable.

The antenna cables are shielded and they should not be affected by any magnetic field. It is recommended to avoid the cables being installed in parallel with any AC wiring as it may possibly cause malfunction of the equipment.

## Ship's Power Supply

The Thuraya MNB-01 (including to the Terminal and the Active Antenna) standby power is only less than 10 W, and the standard operation average power consumption is only 16 W. When low signal strength, burst power may be beyond 20 W. For the steady operation, the input voltage for MNB-01 System needs a 36 W power supply (may be 12 V DC@3 A or 24 V DC@1.5 A). It is recommended to use a 24 V DC power line, if available on the ship.

In case of unavailability of a 12 V or 24 V DC power line on the ship, on external AC/DC power supply (110/220 V AC to 24 V DC @ Min 1.5 A) can be used, please contact the vendor when you need it.

## Equipment Ventilation

To ensure adequate cooling of the terminal, 5 cm of unobstructed space must be maintained around all sides of the unit except the bottom side. The ambient temperature range of the below decks terminal is: -15 °C to + 55 °C.

The equipment should not be operated in the presence of flammable gases or fumes as well as any explosive atmosphere. Operation of any electrical equipment in such an environment constitutes a safety hazard.

# Obtaining License/Approval for using Thuraya MNB-01

Under rights given under ITU Radio Regulations, local telecommunications administrations establish and enforce national rules and regulations governing types of emissions, power levels, and other parameters that affect the purity of signal, which may be radiated in the various frequency bands of the radio spectrum.

To legally operate the Thuraya MNB-01 system, it is necessary to obtain permission from the local telecommunications regulatory authorities of the country you are operating from. Using your equipment in any country without permission causes you to run the risk of confiscation of the equipment by the local authorities. The normal procedure to bring such equipment into another country is to apply for a license before travel. If a license has not been obtained before travel, the equipment may be put in to storage by local authorities until such time license is obtained.

Information in this document is subject to change without notice and does not represent a commitment on the part of Thuraya Telecommunications Company.

## Copyright

Copyright © 2019 Thuraya Telecommunications Company. All rights reserved.

## Trademarks

- THURAYA and the THURAYA logo are registered trademarks of Thuraya Telecommunications Company.
- All other trademarks and copyrights are the property of their respective owners.
- Thuraya MarineStar is a registered brandname for the Thuraya product model number: MNB-01

# INTRODUCTION

---

The MNB-01 is an affordable and robust voice satellite terminal with tracking and monitoring capabilities. The terminal is easy-to-install and user-friendly enabling satellite voice calls to landlines, mobile phones and other satellite phones through the Thuraya satellite network.

The MNB-01 also supports SMS services through its easy-to-use menu on the color LCD screen on the terminal. An SOS button is available to notify pre-configured contacts during an emergency. When the SOS button is activated, the MNB-01 will send a pre-determined SOS message which includes the time-stamped GPS coordinates of the position to a maximum of five preset contacts for emergency response. The terminal has a RJ11 socket for connecting to an analogue phone or PBX.

## Key Highlights

- Quick and easy to install
- Circuit-switched voice
- Fish catch reporting capability
- Advanced 2-way vessel tracking and monitoring based on time, distance, speed and area
- OTA (over-the-air) programming capabilities
- Versatile physical interfaces
- SOS alert
- Geo-fencing capability
- Push notifications for weather, news and other alerts
- Radio silence
- Low and high voltage input power indicator
- Languages: English, Chinese, Vietnamese, Japanese, French, Arabic, Bahasa, Tagalog, Turkish



# Features

## Base Terminal

- Supports basic telephony functions, Calling Line Identification Presentation (CLIP) and Short Message Services (SMS), network function and link to circuit switch phone or PBX function.
- Multilingual MMI – Supports English, Arabic, Chinese, Japanese, Vietnamese, Bahasa, Tagalog, French, Turkish.
- Fish catch reporting:
  - Supports data entries of up to 10 types of fish species and respective catch weight. The data entry of fish species can also be entered from remote server if Integrated on the Thuraya network.
  - Supports vessel info and fish gear entries.
- Tracking
  - Automatic Position Reports (APR) based on Area, time, distance and speed
  - Polling for an on demand position report base on GPS Tracking
  - Geo-fencing area classified into two types namely Restricted zone and Radio Silence. Sends an SMS alert when the vessel enters or leaves an area.
  - Speed alerts are based on Low and High values. Sends an SMS alert when the vessel goes below the Low value and above the High value.
- Interfaces:
  - RS-232 port: A serial interface to manage GmPRS sessions when connected to a Laptop. It can also be connected to 3rd party devices to enhance the device functionality for integration needs.
  - GPIO: Supports 2 input and 2 output ports which can be connected to 3rd party sensors for monitoring or triggering operational activity purposes respectively.
  - NMEA: Provides GPS information in NMEA (GLL/RMC) format.
  - RJ11 port for analogue phone connection complimented by inbuilt PBX for office-on-bridge functionality
  - 3.5mm audio output for external connections
- SOS button for triggering an emergency alert to pre-configured contacts via SMS
- Phone book retrieval from the terminal, storage 255 contacts max
- Call log: last missed, received and dialed calls each with date and time stamps, storage 20 call log max
- Menu-driven graphical user interface with 65K colors, 320 x 240 pixels, 2.4 inch TFT LCD screen
- Back-lit keypad
- Desk and wall mounting



### NOTE

*Language access may vary as per regional requirements.*

## Antenna Unit

- Omni-directional active Thuraya satellite antenna with build-in active GPS antenna
- Standard cable lengths for Sat and GPS is 25m. For longer cable length requirements, please contact your supplier.

# Recommended cable lengths for active antenna

## SAT & GPS Cables

Cable Type	Cable Loss @ 1.5GHz(dB/m)	Max. Cable Length (m)	Typ. Cable Length (m)	Min. Cable Length (m)
LMR-240	0.324	40	34	31
LMR-400	0.174	74	63	57
LMR-500	0.143	90	76	70

## Operating Environment

Antenna Unit (ADU)	
Operating Temperature	-25 °C to +55 °C
Storage Temperature	-40 °C to +80 °C

Base Terminal (BDU)	
Operating Temperature	-15 °C to +55 °C
Storage Temperature	-20 °C to +70 °C

System	
Power Supply	10.8 to 31.5 V
Standby / Working Average Power Consumption	10 W / 16 W
Operating Humidity	5 to 95 % RH at 40 °C

# General specifications

## Service

<b>Voice</b>	<b>Circuit switched</b>	
<b>SMS</b>	Up to 160 characters (English)	
<b>GmPRS</b>	60Kbps / 15Kbps (Download / Upload)	
<b>Ingress Protection Rating</b>	Base Terminal (BDU)	IP 32
	Antenna (ADU)	IP 66

## GPS specifications

<b>Number of Tracking Channels</b>	72	
<b>GPS Position Accuracy</b>	<10 m	
<b>Time to First Fix</b>	Hot start	< 1 seconds
	Cold start	< 30 seconds

## Mechanical specifications

Size	
Base Terminal (L x W x H)	203 × 190 × 72.7 mm
Active Antenna (D x H)	185 × 170 mm
SAT Cable	25 meters
GPS Cable	25 meters
Weight	
Gross weight & dimensions (L x W x H)	6.7 kg & (305 x 250 x 275 mm)
Base Terminal	1.07 kg
Active Antenna	1.30 kg
Antenna Mounting Kit	0.53 kg
SAT cable	1.02 kg @ 25m
GPS cable	1.00 kg @ 25m
Remaining accessories	0.27 kg

Active antenna specifications	
EIRP	5 dBW (Min.), 7 dBW(Typ.)
Frequency	1525 – 1559 MHz, 1626.5 – 1660.5 MHz
Polarization	LHCP (Left Hand Circular Polarization)
Axial ratio	< 6 dB
Gain-to-noise Temperature ratio	-24 dB/K (Typ.), -22 dB/K (Min.)

## Compliance

- Thuraya approved
- Compliant to CE, RoHS, REACH, IEC60945 & 62368, RED & RCM

# Packing list



Base Terminal



Active Antenna



Antenna Mounting Kit  
(L shaped based plate, 2 U  
clamps, 4 M6 nuts & washers)



Power Cable  
(5 meters with 2P circular cable  
connector)



SAT RF Cable  
(25 meters with N-type Male  
connectors)



GPS RF Cable  
(25 meters with SMA Male  
connectors)



Miscellaneous  
(User manual, Wall mount paper,  
5 M5 screws for ADU installation,  
6 mounting screws and washer  
for BDU installation, SIM adaptor,  
IMEI label and Butyl type)

# Base Terminal

## Introduction of Ports

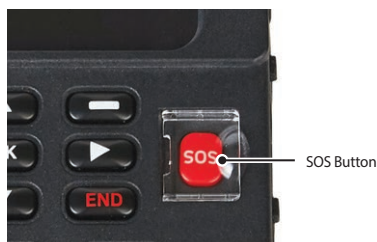

---

<b>SOS Button</b>	For emergency usage. To notify pre-configured contacts during an emergency. Press and hold the RED key for 2 seconds to trigger the alert.
-------------------	--------------------------------------------------------------------------------------------------------------------------------------------

---

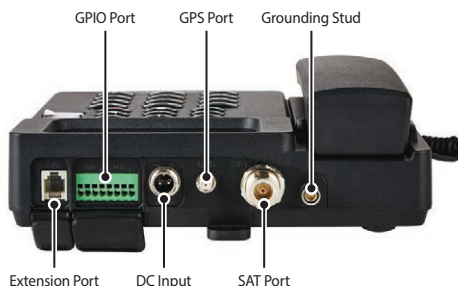

---

<b>Grounding Stud</b>	To ground the terminal with a grounding cable.
<b>SAT Port</b>	SAT ANT port is used for the physical connection - via an RF cable between the satellite active Antenna unit and the Base Terminal.
<b>GPS Port</b>	GPS ANT port is used for the physical connection between the GPS antenna and the Base Terminal.
<b>DC Input</b>	Power input connector is used for connecting the external power source (10.8 – 31.5 V) to the Base Terminal and active antenna.
<b>GPIO Port</b>	GPIO_1 is used for connecting external button switches to pin 1 and 2 as input port. It can be set as SOS or General and when set to SOS it functions like the SOS button on the keypad. GPIO_3 is used for connecting buzzer or external device to pin 5 and 6 as output port. (Pin 5 8V output and Pin 6 GND) When set to Buzzer, the buzzer will sound when the phone rings and when the alert sounds. When set to General, the server receives a separate control command and outputs 8V according to the control command.

---

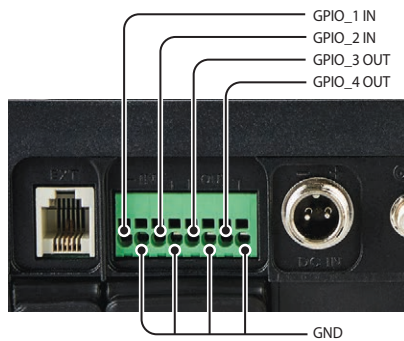

---

**RJ-11 (Extension Port)** To connect the analogue handset.

---



- 
- 3.5mm Audio Port** This is the system voice port, which could connect a loud speaker to play the calling voice.

---

  - NMEA Port** For sending GPS signal in NMEA format (GLL, RMC protocol) to 3rd party devices.

---

  - Serial Port** This is RS232 port for 9 wired (TXD, RXD, CTS, RTS, DTR, DSR, DCD, RI and GND). It is for communication module maintenance, Firmware upgrade, GmPRS service usage and 3rd party device integrations. For more information, please contact your distributor.

---

  - Power ON/OFF button** This is the system power On/Off switch.

---



---

**SIM Card Slot** To insert Thuraya SIM Card.

---

**Micro USB Port** It is for terminal debugging. For more information, please contact your distributor.

---



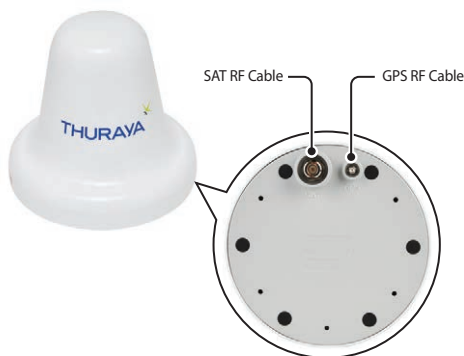

The Antenna unit has two RF (female) connectors at its base. One connector is the **SAT signal port** (N-type connector), and the other is the **GPS signal port** (SMA connector).

<b>SAT RF Cable</b>	The SAT RF cable is 25 meters in length and is terminated with an N-type (male) connector at each end.
<b>GPS RF Cable</b>	The GPS RF cable is 25 meters in length and is terminated with a SMA (male) connector at each end.
<b>Mounting Bracket</b>	To mount the antenna on the bracket.
<b>U-Clamps</b>	To fix and fasten the antenna mounting bracket on a pole or railing on the ship.

# INSTALLATION

---

This section describes how to install the Thuraya MNB-01 terminal and connect all the cables.

## Unpacking BDU



# Installation of Base Terminal

- 1 Select a suitable location inside the wheelhouse or the cabin room where you desire to place your Base Terminal. It is designed to operate in rooms with a temperature range from -15 °C to +55 °C.
- 2 Mount your Base Terminal onto a wall or place it on a desk or tabletop.
- 3 In case of mounting the Base Terminal onto a wall, fix it in the proper position using the Wall mount paper and mount the BDU onto a wall. Then tighten SCREW 5 together with the WASHER.

**!** **NOTE**

The terminal must be installed within the area where the ground can be connected via a separate port in the terminal.

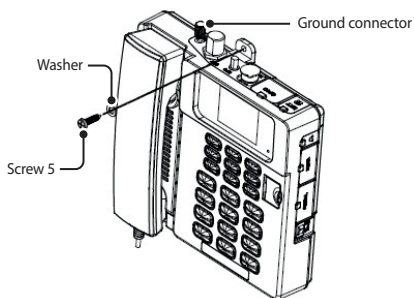

## Wall mount paper

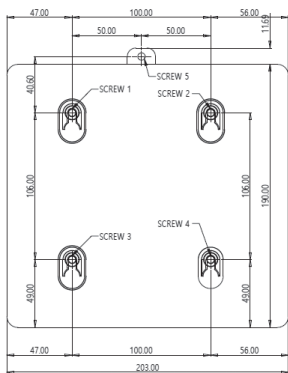

The mounting location hole (unit: mm)  
Screw type: 5 mm x 20 mm Stainless steel tapping screw

# Unpacking ADU



## Radiation hazard

The MNB-01 antenna radiates 7.5 dBW EIRP. This translates to a minimum safety distance of 0.4 m from the antenna while it is transmitting, based on a radiation level of 10 mW/cm<sup>2</sup>.

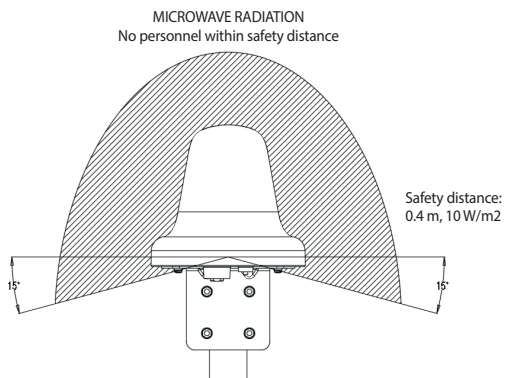

## Interference

The antenna must be mounted as far away as possible from the ship's radar and high power radio transmitters (including other Inmarsat based systems), because they may compromise the antenna performance. RF emission from radars might actually damage the antenna.

The MNB-01 antenna itself may also interfere with other radio systems.

It is difficult to give exact guidelines for the minimum distance between a radar and high power radio transmitters because radar and high power radio transmitter power, radiation pattern, frequency and pulse length/shape vary. Further, the antenna is typically placed in the near field of the radar antenna and reflections from masts, decks and other items in the vicinity of the radar are different from ship to ship.

However, it is possible to give a few guidelines:

Since a radar and high power radio transmitters radiates a fan beam with a horizontal beam width of a few degrees and a vertical beam width of up to  $\pm 15^\circ$ , the worst interference can be avoided by mounting the antenna at a different level – meaning that the antenna is installed minimum  $15^\circ$  above or below the radar antenna.

And due to near field effects recommend to separate at distances about 10m (d) between radar antenna and the MNB-01 antenna. Therefore it is recommended to ensure as much vertical separation as possible when the MNB-01 antenna has to be placed close to a radar antenna.

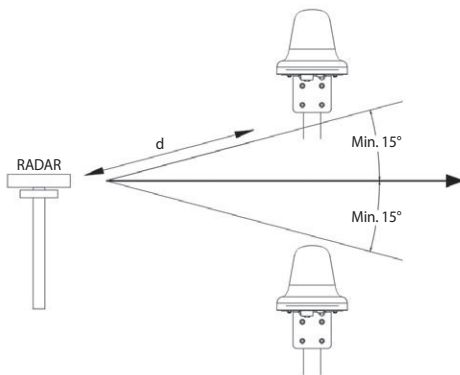

# Installation of Antenna Unit

- 1 Select an ideal location above the deck where you desire to place your Antenna Unit. It is recommended to install it at a point where no surrounding obstacles should obstruct the open sky view to the antenna and make sure there is no other radio equipment or vessel funnel. It is designed to operate within a temperature range from -25 °C to +55 °C.
- 2 Find a proper pole which can withstand 1.4 kg and fix Antenna unit using U-clamp as shown below. It is recommended that the Antenna unit to be installed on a pole with a diameter of between 38 mm and 45 mm (1.5 inches and 1.7 inches).
- 3 Ensure to have good and clean grounding for the antenna installation.

Tighten the ground cable to one of the M5 screw.

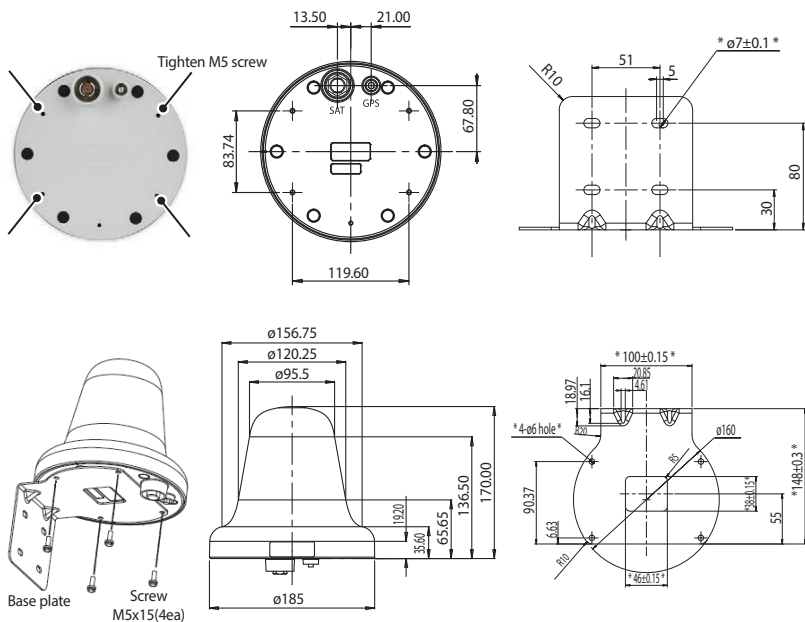

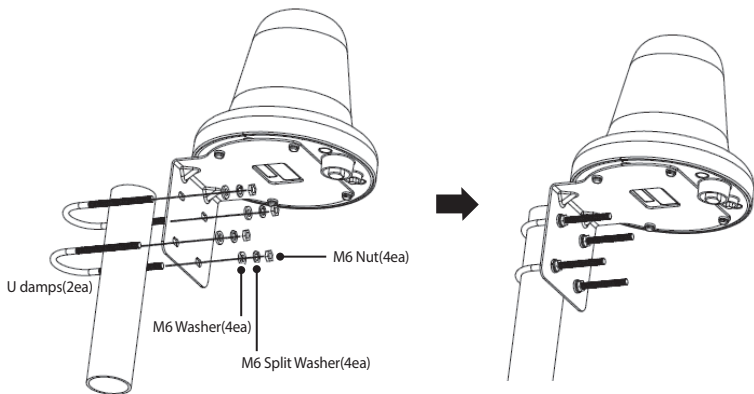

- 4 Connect the cables between Base Terminal and Antenna unit.
  - SAT RF cable shall be connected to the N-TYPE CONNETCOR of Antenna Unit.
  - GPS RF cable shall be connected to the SMA CONNETCOR of Antenna Unit.
- 5 After tightening the connectors, wrap the connectors with Butyl tape supplied in the packaging or apply silicon sealant to make them waterproof.

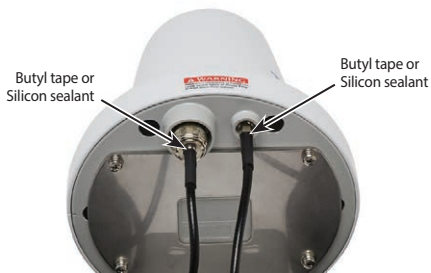

- 6 Fix the cables to the pole with cable tie.
- 7 The cables shall be bent after having a straight section of at least 100 mm from the antenna. The bending radius of the cable shall be at least 50 mm.
- 8 Connect and tighten the SAT and GPS cables to the connectors on the Base Terminal.

**9** Tighten a DC power cable to the DC connector of Base Terminal as follows.



**10** Connect the Base Terminal to a DC power source using the DC power cable supplied in the box. Recommended specifications are 12 V/3.6 A or 24 V/1.8 A.



# GETTING STARTED

## Installing the SIM card

The Thuraya MNB-01 system requires a valid and active SIM card to access the satellite network and configure the settings of the Base Terminal.

Follow these steps to install the SIM card:

- 1 Unscrew the SIM card cover and flip it down.
- 2 With the SIM card's gold contact facing down, position the card as indicated and slide it into the slot.
- 3 Ensure that the SIM card is correctly inserted.
- 4 Close and fasten the screw of the SIM card cover.

## Power up the MNB-01

### Follow these steps to power up the MNB-01

- Tip the Power On/Off Switch on the left.



Power switch

- LED indicator to show green for successful input power. If it is flickering, then it is receiving either low voltage or high voltage.

## Basic Terminal Set Up



### NOTE

*Before making a voice call, please make sure that:*

- *The SIM card is properly inserted in the SIM card slot.*
- *There should be at least 2 bars on the signal strength.*





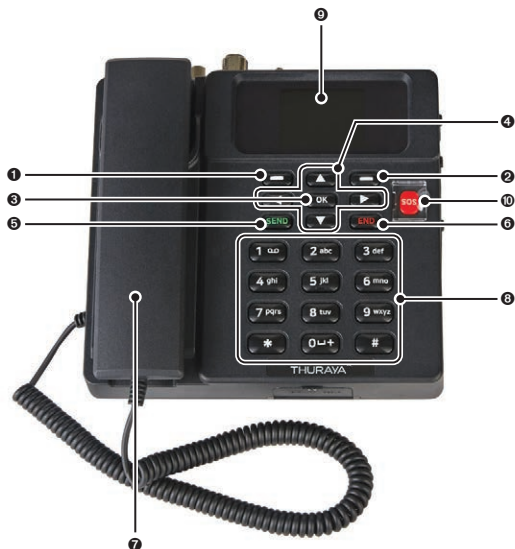





# USING THE MNB-01

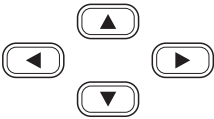

1	Left Function Key	6	End Key
2	Right Function Key	7	Handset (Ring tone speaker underneath)
3	Okay Key	8	Keypad(Alpha-numeric)
4	4-Way Navigation Buttons	9	2.4 inch 65K color TFT LCD Screen
5	Send Key	10	SOS Button

## Keypad- Description and Functions

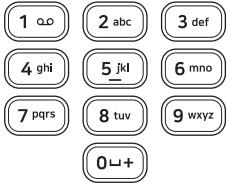
Keys	Description / Functions
	<b>Left Function Key</b> The Function of this key depends on the guiding text shown on the display above this key.

Keys	Description / Functions
	<p><b>Right Function Key</b></p> <p>The Function of this key depends on the guiding text shown on the display above this key.</p>
	<p><b>Okay Key</b></p> <p>Pressing this key selects or confirms the function highlighted on the display.</p>
	<p><b>4-Way Navigation buttons</b></p> <p>Press the 4-Way navigation buttons to scroll left, right, up and down on the display. Enables scrolling through names, phone numbers, menus or settings.</p>
	<p><b>Send Key</b></p> <p>This function is to make a call when the handset is off hook.</p>
	<p><b>End Key</b></p> <p>This function is to...</p> <p>Press this key once to clear one character at a time or press and hold this key to clear the whole text entry.</p>
	<p><b>SOS Button</b></p> <p>Press this key to notify pre-configured contacts by SMS during on emergency.</p>
	<p><b>Keypad</b></p> <p>Used to enter numbers or characters.</p> <p>Press 0 to add a space when writing the text.</p> <p>The functions available depend on whether you are typing a phone number or text.</p>
	<p><b>Star * Key</b></p> <p>When entering a phone number, press this key to insert a *.</p> <p>When writing text, press this key to access a list of special symbols.</p>
	<p><b>Hash # Key</b></p> <p>When entering a phone number, press this key to insert a #.</p> <p>To quickly change the text input method when writing text, press this key repeatedly and check the indicator at the top of the display.</p>



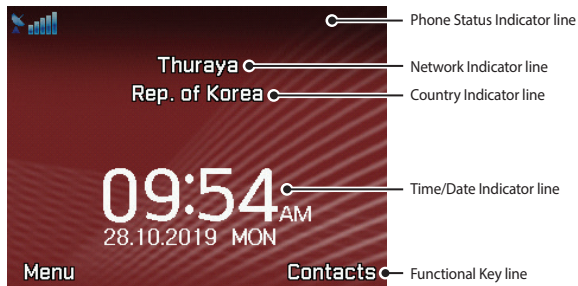





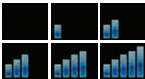

# The Home Screen













<b>Phone Status Indicator line</b>	This indicator line shows status symbols of the operating conditions (signal strength received) of the MNB-01 terminal.
<b>Network Indicator line</b>	This indicator line shows the registration status and region information of the MNB-01 terminal or the GSM Mobile network operator sim card roaming on the Thuraya satellite network.
<b>Country Indicator line</b>	This indicator line shows the Country information.
<b>Time/Date Indicator line</b>	The Time/Date Indicator line by default shows UTC time, it can be set to show a local time zone if required.
<b>Function Key line</b>	This Function key line operates using the Left or Right function keys with the  to access menus and controls.

## Status Indicators

Tables below explain the meaning of each status indicator displayed in the Home screen.

Status Indicators	Description
	Satellite signal
	Status bar
	Radio silence
	Weak signal. Point antenna towards satellite
	Roaming
	Active call
	Mute
	Silent
	Call divert
	GmPRS connecting (blinking icon during a GmPRS connection)
	GmPRS paused

Status Indicators	Description
	SOS activated
	SOS message
	Unread SMS
	Voice mail
	Voice mail + SMS
	SMS inbox full
	Tracking message
	Tracking activated
	Alarm
	Schedule reminder
	Sending and receiving data from an external device

## Making / End a Voice Call

**NOTE**

Before making a voice call, please make sure MNB-01 has registered the network and signal strength status indicator should be on (  ). There should be at least 2 bars on the signal strength.

To make a call from the Base Terminal, off-hook the handset cradle and dial.

+<country code><phone number> and press  key

or

00 <country code> <phone number> and press  key

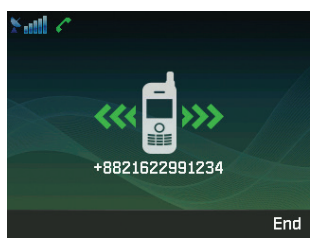

**NOTE**

For voice calls in dial, you may also use '+' by pressing and holding the  key instead of "00" at the beginning of dialed number string as an alternative('+<country code> <phone number>).

To end the call, re-place the handset on the cradle.

## Receiving a call

When there is an incoming call, the MNB-01 terminal will:

- Ring
- The calling party's number will be displayed on the screen.  
The corresponding name of contact will be displayed if the number is stored in the contacts.

To answer an incoming call, pick up the handset from the cradle or from the analogue phone, if connected.

## Adjusting volume during a call

Use Left  / Right  Function Key adjust the volume.

# Using the Main Menu

## Menu Flow schematic

### Messages

- 1 New Message
- 2 Inbox
- 3 Draft
- 4 Sent messages
- 5 Outbox
- 6 Templates
- 7 Settings [C]
- 8 Info message
- 9 Memory status
- 10 Delete messages [A]

### Contacts

- 1 Search
- 2 Add contact
- 3 Group
- 4 Speed dial
- 5 Delete [A]
- 6 Memory status

### Call logs

- 1 Missed calls
- 2 Received calls
- 3 Outgoing calls
- 4 Delete [A]
- 5 Call duration

### Organizer

- 1 Calendar
- 2 Calculator

### Clock

- 1 Alarm
- 2 World time
- 3 Time/Date

### Sounds

- 1 Ringtones [C]
- 2 Ringing type [C]
- 3 Keypad tone [C]
- 4 Startup sound [C]
- 5 Volume [C]



## Network

- 1 Network mode [A]
- 2 SAT registration [A]
- 3 Preference [A]

## Security

- 1 SIM pin code [C]
- 2 Security code [C]
- 3 Call barring code [C]
- 4 Fixed dialing [C]
- 5 Closed user group [C]
- 6 IMEI number
- 7 S/W version
- 8 Soft reset [C]
- 9 Factory reset [A]
- 10 Device-SIM pairing [A]
- 11 Remote server authentication code [A]
- 12 Administrator function
- 13 Crew calling [C]
- 14 Captain function
- 15 NMEA port

## Settings

- 1 Phone [C]
- 2 Call [C]
- 3 GmPRS [A]
- 4 Language [C]
- 5 Data connection [C]
- 6 Setup wizard [C]
- 7 My numbers [C]
- 8 Alert events [A]
- 9 GPIO [A]

## Navigation

- 1 Current position
- 2 Waypoints
- 3 Navigation system type [C]

## SOS [C]

- 1 Message recipient(s)
- 2 SOS message (SMS)
- 3 SOS message (email)
- 4 Message interval
- 5 Output format

## Location

- 1 Tracking [A]
- 2 Geofence [A]
- 3 Fish Catch and Vessel details
- 4 Settings [A]
- 5 Log list



### NOTE



- To access menu's indicated with [C], activate Captain mode.
- To access menu's indicated with [A], activate Admin mode.

You can access the Main Menu by pressing the Left Function (  ) key or (  ) Key from the Home screen.



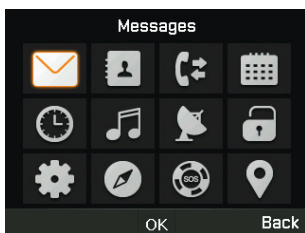











The Main Menu includes 12 menu options with each menu option having their respective sub-menus.



You can use the 4-Way navigation buttons to navigate to the desired menu option and press (  ) to confirm your selection. You can also end the menu or sub-menus and return to the Home screen at any time by pressing the (  ) key or continuous pressing the Right Function (  ) key many times.

**Table below summarizes the functionalities within each menu option:**

Icon	Description
	<p><b>Messages</b></p> <p>This menu manages your user messages.</p>
	<p><b>Contacts</b></p> <p>This menu manages your user contacts.</p>
	<p><b>Call logs</b></p> <p>This menu allows you to manage your call history.</p>
	<p><b>Organizer</b></p> <p>This menu contains useful tools such as Calendar and calculator.</p>
	<p><b>Clock</b></p> <p>This menu is used to set the date and time. This is also used to set up alarms.</p>
	<p><b>Sounds</b></p> <p>This menu is used to configure sounds being played on the device for respective activities.</p>
	<p><b>Network</b></p> <p>This menu configures terminal's network settings.</p>
	<p><b>Security</b></p> <p>This menu is accessed in the Admin mode to configure sim and device codes and access to reset.</p>
	<p><b>Settings</b></p> <p>This menu is accessed in the Admin mode to configure sim and device codes and access to reset.</p>
	<p><b>Navigation</b></p> <p>This menu helps the user benefit from its navigation ability.</p>
	<p><b>SOS</b></p> <p>This Menu is used to manage the SOS button alerting incase of emergency.</p>
	<p><b>Location</b></p> <p>This menu is used to manage inbuilt device value added services.</p>

# Messages

Once you select the messages menu, you will see the below sub menu's.

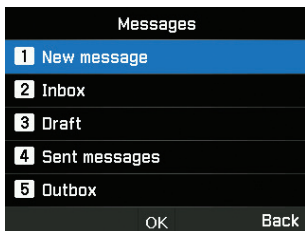

## New message

You will be able to create new SMS either by input of text or from a standard template and send it as an SMS or email which is user defined.

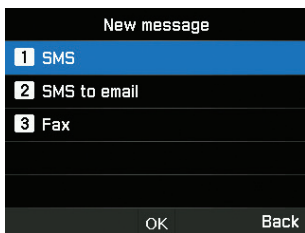

- 1 To send a new message, go to **Menu > Messages > New message** and you may choose to send an SMS, SMS to email, or Fax.
- 2 Enter the message.
- 3 Select **Options > Send**.
- 4 Add the information of the recipient(s).
- 5 Select **Send**.



### NOTE

*The maximum number of characters for message is 160 (English).*

You can also save the incomplete messages as a draft by pressing **Option** > **Save as draft**.

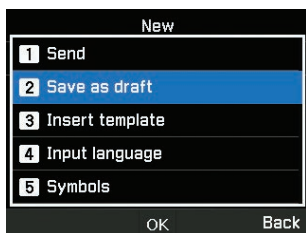

## Inbox

Once you received an incoming SMS, you will be able to view this information in this menu.

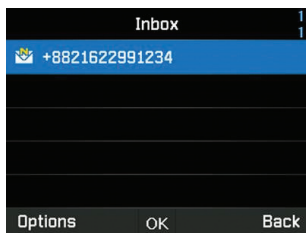

You can choose to reply, forward, save the SMS as a template for future reference or delete it by selecting Options.

The incoming SMS sender can also be saved as a contact.

## Drafts

You can create your own drafts, copy it to be pasted wherever required, save it as a template or for future use.

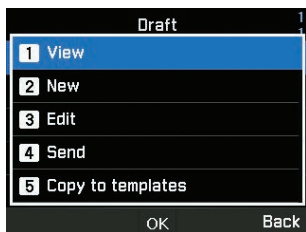

## Sent messages

You can view, forward or copy to templates the previously sent messages.

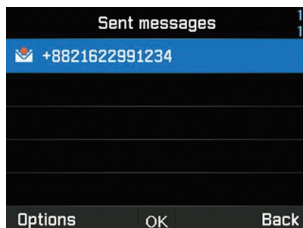

## Outbox

Outbox contains messages that are not delivered. You can perform similar activities that are done in sent items.

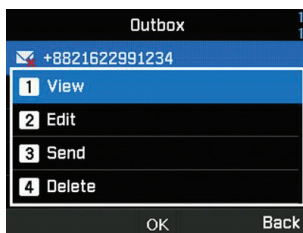

## Templates

The templates defined or saved can be sent instantly. You can modify existing ones or create new of your own.

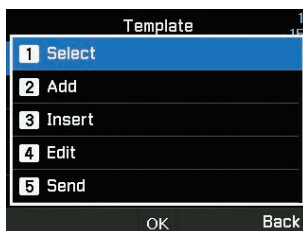

## Settings

This section contains crucial information on the SMS and email centers which is to be defined for tracking purposes. Activate captain mode

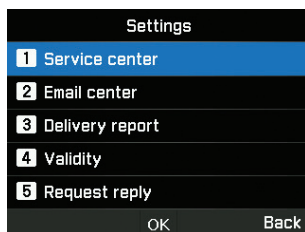

You can also activate the delivery report notification and enable/disable the request reply function.

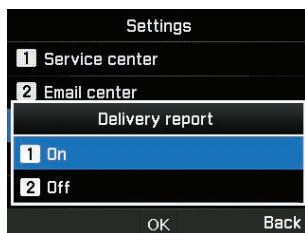

Maximum, 1 Hour, 6 Hours, 1 Day, 3 Days and 1 Week can be selected for the validity.

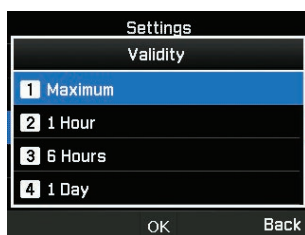

### NOTE

*Maximum settings as per the operator.*

Select the SMS server or GmPRS server for Bearer mode.

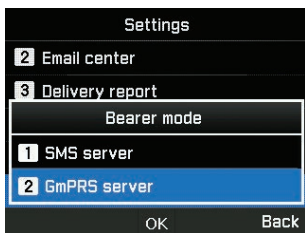

### Info message

This menu is used to display the information received from the system. Activate captain mode to access the Language menu under main menu settings.

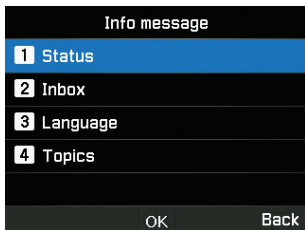

### Memory status

You can see the total and used memory of the device. The maximum storage space available in the phone is 550 (Inbox: 250, Draft: 100, Sent: 150, Outbox: 50).

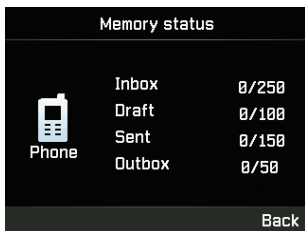



## Delete messages

This menu is used when you want to delete the SMS's from all menu's under Messages. Activate admin mode.

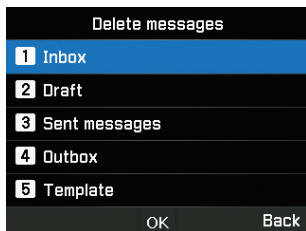

# Contacts

The contacts menu helps you to manage your address book by saving and editing contacts on your device.

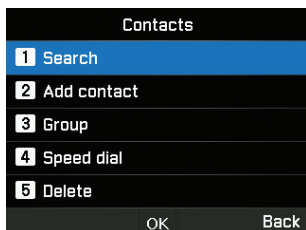

## Search

This menu is used to find a contact saved in the device. Enter the name using the keypad.

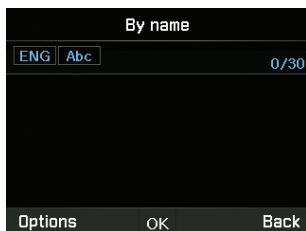

## Add contact

You can add a contact and save using this menu. Enter a phone number and press the **OK** key. Or go to **Contacts > Add contact**.

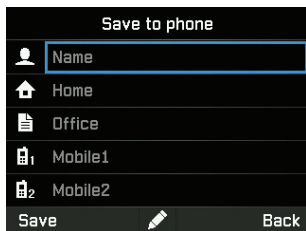

## Group

You can create new or modify existing groups in which contact are added. Specific ringtones can be set for every group and also useful in sending group SMS.

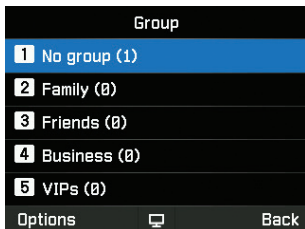

## Speed dial

This menu is used to assign contact numbers as speed dial from 1 to 9. They can be edited when needed. To add a contact to Speed dial, go to **Menu > Contacts > Speed dial**. Select the desired key and select **Options > Assign**.

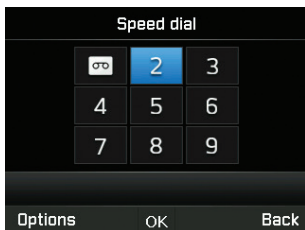

## Delete

You can delete contacts one by one or all at once. Activate admin mode.

## Memory status

You can view how much memory is available on the phone for contacts. You can save contacts up to 255.

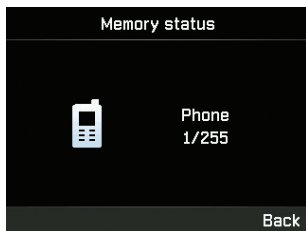

### NOTE

*Sim contact or memory is not displayed.*

# Call logs

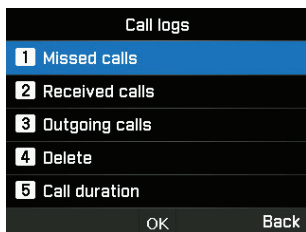

## Missed calls

You can view the missed calls list and save it to contacts or delete it or dial-out by pressing **SEND** key.

## Received calls

You can view the received calls list and save it to contacts or delete it or dial-out by **SEND** key.

## Outgoing calls

You can view the outgoing calls list and save it to contacts or delete it or dial-out by **SEND** key.

## Delete

You can delete call list by type or all types at once. Activate admin mode.

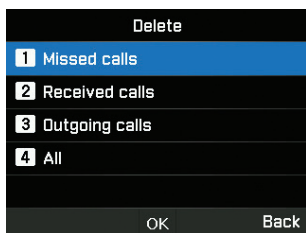

## Call duration

You can view the call duration by type or all combined. GmPRS usage duration can be viewed in this menu. All the durations can be reset in captain mode.

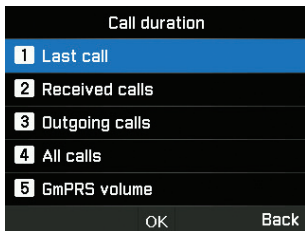

### NOTE

*Each log can store up to 20 records and shows call duration and time of call.*

# Organizer

This menu is used to access useful tools like calendar and calculator.

## Calendar

You can set reminders in this device. It can be viewed as a list or modified as needed.

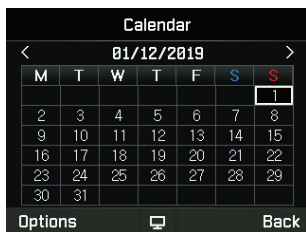

- 1 Select the date that you want to add the reminder.
- 2 Add the reminder at the selected data by pressing **Options** > **Add** and save it.

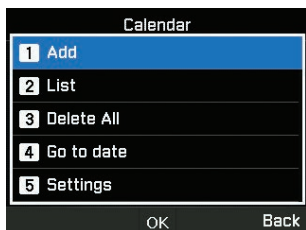

- 3 Set the alarm details.

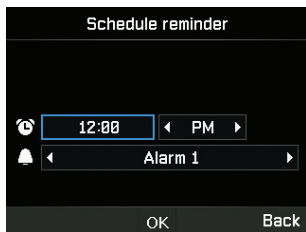

You can also view the list of schedule reminders, delete it, go to the specific date or set the Weeks starts on details in this menu.

## Calculator

You can use the calculator when needed.

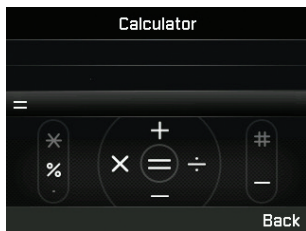

### NOTE

- Short-press \* for Dot or % Operation
- Long-press \* to change between Dot(decimal point) and % Operation
- Press # for -(Negative) operation



# Clock

You can set the alarms, date and time in this menu.

## Alarm

You can view the alarms list and modify it.

- 1 Select a day of the week (Multiple selections possible).
- 2 Enter the time.
- 3 Select an alarm sound.
- 4 Turn On/Off the alarm.
- 5 Press **Save** to apply the change.

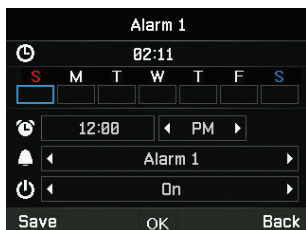

## World time

You can view the world times in different zones by selecting the location in world map. Select your city with the direction keys and press the OK button to save it. You will see that the world time is aligned in reference to the selected city next time you enter the world time menu.

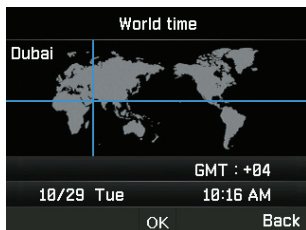

### NOTE

*World time is calculated based on the set local time. Therefore incorrect local time will result in incorrect world time.*

## Time/Date

You can set the time and date for your device in the format you select (Explanation on how to do it with snapshot).

# Sounds

You can manage the device activity sounds in this menu. Activate captain mode.

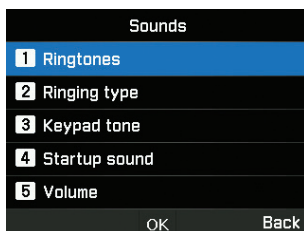

## Ringtone

You can view and set the ringtone the type needed.

## Ringtone type

You can enable or disable the ringing sound.

## Keypad tone

You can enable or disable the keypad tone.

## Startup sound

You can enable or disable the startup sound.

## Volume

As required, you can modify the volume levels from the default levels set on the device.

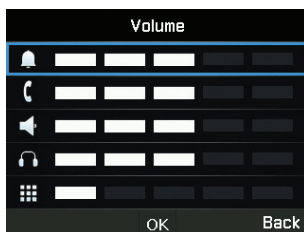

# Network

You can manage the device network settings using the admin mode.

## Network mode

This allows you to choose if the device needs to automatically or manually choose the network.

- 1 Go to **Menu > Network > Network mode** and you may choose **Automatic** or **Manual**.
- 2 Select **OK**.

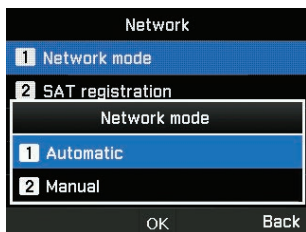

## SAT registration

If the SAT icon on your screen is blinking you may not be able to make or receive SAT calls. In this case you can update the SAT registration manually by going to **Menu > Network > SAT registration**.

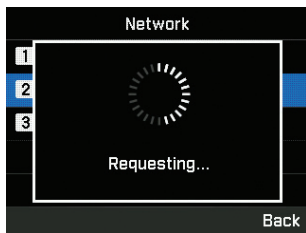

## Preference

Display the preferred list of networks registered on your SIM card. You can add or remove entries in this list.



# Security

You can manage the device security settings using the admin mode or captain mode.

## WARNING

Do not lose the new passwords or codes if changed from the default. You may contact the service provider or may require factory reset if you lose the passwords. Please refer to page 55 for more information on factory reset.

## SIM pin code

The Captain can enable and set the SIM pin codes. If a wrong SIM pin code is entered three times, the terminal will be locked and the correct PUK code must be entered to access the terminal again.

You received your PIN and your PUK codes together with your SIM card. Input PIN1 code after selecting On.

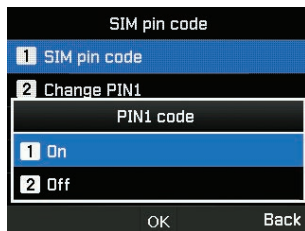

## Security code

The Captain can enable and set the device security code.

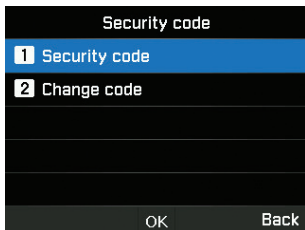

### NOTE

*The initial security code of your MNB-01 is '0000', and this code can be changed in the Change code menu.*

## Call barring code

The Captain can enter call barring code for call restriction functions. Call barring code varies with different service providers and should be supplied by your service provider when you start using the terminal. When the barring code is lost, please contact your service provider.

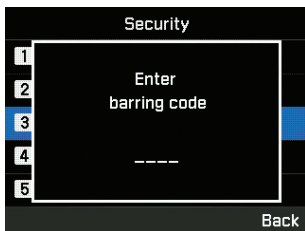

## Fixed dialing

The Captain can view and modify fixed dialing settings. Fixed dialing is a function where only the predefined numbers can be called. To adding the new number PIN2 code shall be entered.

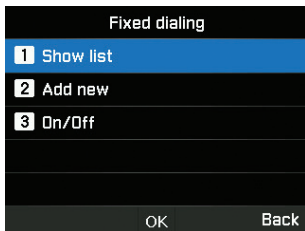

## Closed user group

The Captain can enable/disable and set a preset for the CUG. To use the CUG function, please contact your service provider for details.

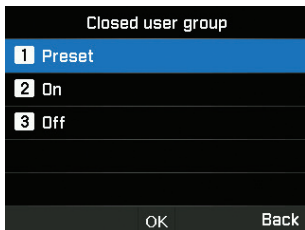

## IMEI number

You can view the IMEI number.

## S/W version

You can view the software version.

## Soft reset

The Captain can reset your MNB-01 without losing your personal settings like contacts or messages.



## Factory reset

The factory reset will restore the settings as the terminal was shipped in admin mode. You will lose your custom settings like contact, messages, tracking, SOS and all information saved on the terminal.

## Device SIM-Pairing

This feature allows the device to be functionally locked with a specific SIM-card in admin mode. If you insert another SIM card that is not paired with the terminal, then you shall need to enter the special PIN security code to use the terminal. Please contact your service provider for details of the special PIN security code.

## Remote server authentication code

You can manage the third party remote server integration authentications using admin mode.

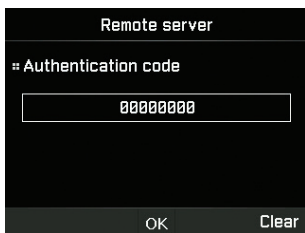

### NOTE

*Four to eight-digits can be entered for the authentication PIN code.*

## Administrator function

You can enable/disable the Administrator function and manage the admin level password for the device using admin mode.

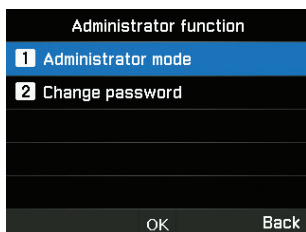

### NOTE

*The initial admin password of your MNB-01 is '00000000', and this password can be changed in the Change password menu.*

## Crew calling

The Captain can allow the onboard crew to use Thuraya pre-paid services by dialing a prefix. This feature is managed through in this menu.

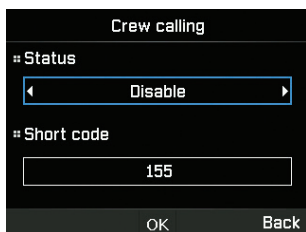

## Captain function

You can enable/disable the Captain function and manage the captain level password for the device using admin mode.

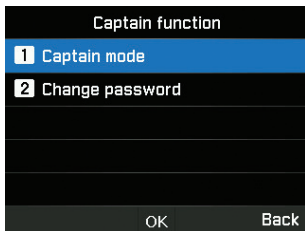

### NOTE

*The initial captain password of your MNB-01 is '00000000', and this password can be changed in the Change password menu.*

## NMEA port

You can enable/disable the port as needed using captain mode.

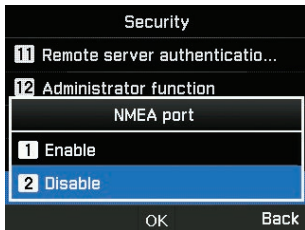

# Settings

You can manage the device settings using the admin mode or captain mode.

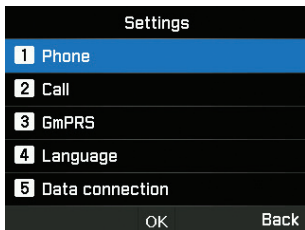

## Phone

You can manage the wallpapers, backlight of LCD using captain mode.

## Call

You can manage the call settings, whitelist and blacklist of numbers and also send own number as an SMS to a requester using captain mode.

### 1. Call waiting

Call waiting allows you to receive an incoming call during an active call by either holding or ending the active call to receive the waiting call. If you want to use this function, you must subscribe to the corresponding service provided by the service provider.

### 2. Call diverting

This function diverts an incoming call to a specific number.

### 3. Call barring

To use the barring service, you must know the barring password for the corresponding SIM and you must be subscribed to the corresponding service provided by the service provider.

### 4. Voice mail

Set a new voice mail number.

### 5. DTMF tone

Set the DTMF tone for ARS call. To enable the function, select On and press the center key to complete the setting.

### 6. Send own number

Choose whether you want to send your own number to the receiver when making a call.

## 7. Cost

This service allows you to have cost control of your outgoing calls. Please note that the actual cost could be different from the calculated costs.

## 8. Call Manager

This function allows you to set up a list of blocked contacts (Black list) or allowed contacts (White list).  
Activate admin mode.

## GmPRS

You can manage the APN type and enable/disable auto reject settings using admin mode.

There are 3 Thuraya APNs available. Select one to use when there is more than one access point name.

- GET (default, no compression)
- GETLC (low compression, images will be compressed)
- GETHC (high compression, images will not be downloaded)

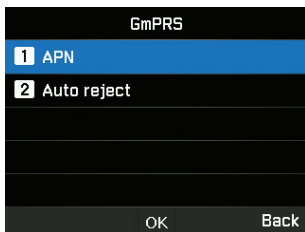

Auto reject determines whether to reject the incoming call when GmPRS connection is active.

## Language

You can manage the multilingual choice for system and text typing language using captain mode. You can also enable/disable the auto text.



### NOTE

*Certain language access may not be available due to regional requirements. Kindly contact your service provider for further information.*

## Data connection

You can manage the RS-232 serial port settings using captain mode.

Data connection port for using GPS data or software upgrade can be configured. Serial is supported as a Data port. The speed of the Serial port can be set to one of 8 available speeds.

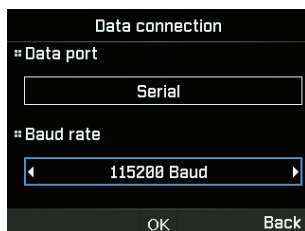

## Setup Wizard

You can perform the basic settings programming using this easy to use menu using captain mode.

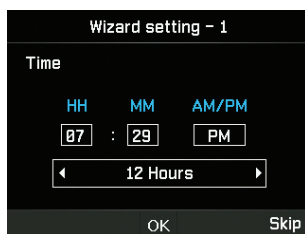

## My numbers

You can register your sim-card voice call number using captain mode.

## Alert events

You can enable/disable some useful trigger levels to be sent as a notification alert from the device to the SMS using admin mode.



Changes in the status of Signal strength, GPS antenna, Power cycle, Reset, GPIO1 and GPIO2 are configured as events on the terminal and the status can be reported to the server from any of its previous states.

## GPIO function

You can enable/disable GPIO function to set the device for the external alert input/output interface using admin mode.

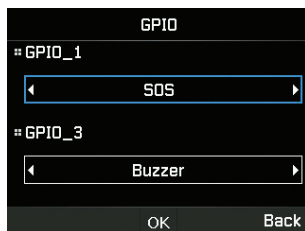

# Navigation

## Current position

View your current position or using an existing way point to find a relative position and send your current coordinates via SMS or email.

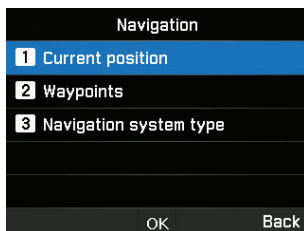

## Way points

Navigate your way using a new way point or an existing one. You can send the way point via SMS or email to other MNB-01 or SMS/Email enabled terminals.

## Navigation system type

You can select two types of navigation systems using captain mode.

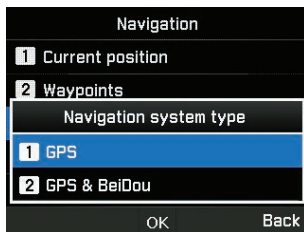



# SOS

MNB-01 allows you to send SOS messages (SMS/email) to pre-determined recipients at the press of a SOS button during an emergency. Activate captain mode.

The screenshot shows a dark-themed configuration screen titled "SOS". It contains three sections, each with a label and a text input field:

- Message recipient(s)**: A text input field.
- SOS message (SMS)**: A text input field.
- SOS message (email)**: A text input field.

At the bottom of the screen, there are three buttons: "Save" on the left, a pencil icon in the center, and "Back" on the right.

Press and hold the Alert button for 2 seconds for the activation. Once the SOS is activated the icon will be shown and flashing in the status bar as per your configuration, And also the idle screen will be flashing in red. To deactivate, press and hold the Alert button for 2 seconds.

## Message recipient(s)

You can view and modify up to 5 recipients with an SMS or email.

## SOS message (SMS)

You can edit the text to be sent in an SOS message sent as an SMS.

## SOS message (email)

You can edit the text to be sent in an SOS message sent as an email.

The screenshot shows a dark-themed configuration screen titled "SOS". It contains two sections:

- Message interval**: Two input fields. The first is labeled "hour(s)" and contains the value "00". The second is labeled "minute(s)" and contains the value "05". Below these fields is the text "(3 mins to 24 hrs)".
- Output format**: A dropdown menu with the selected option "00.ddddd".

At the bottom of the screen, there are two buttons: "Save" on the left and "Back" on the right.

## **Message interval**

You can set the time interval of SOS transmission from device (every 3 minutes to every 24 hours).

## **Output format**

You can set the output format of the SOS message.

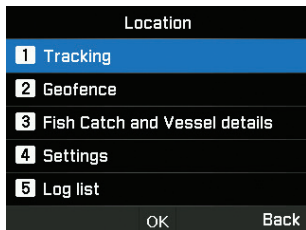

## Tracking

There are four types of tracking available – By area, distance, time and speed. Activate admin mode.



### NOTE

- Every Polygon entry once entered or accessed should be saved along with the area to avoid deletion of the entered data.
- Time interval setting choice in each tracking type is minimum 3 minutes to maximum 10 days.

For Area type, you can input 10 polygons of 3 to 100 geo-coordinates in user selected format. Each area can be renamed and each polygon needs to be sequential and completed.

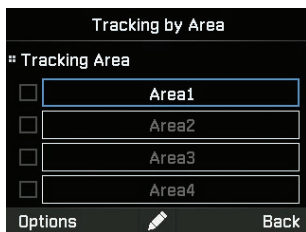

For Distance type, you can input from 0.00 km to 999.99 km.

The screenshot shows a settings screen titled "Tracking by Distance". It has a dark background with white text. At the top, it says "Tracking by Distance". Below that, there are two sections: "Tracking distance" and "Tracking interval". The "Tracking distance" section has a numeric input field with "0" inside, followed by a decimal point and another numeric input field with "00" inside, and the unit "km". Below this, it says "(0.00km to 999.99km)". The "Tracking interval" section has a numeric input field with "00" inside, followed by the unit "day(s)". At the bottom, there are two buttons: "Save" on the left and "Back" on the right.

For Speed type, you can input a lower (0 km) and upper speed limit (999 km) .

The screenshot shows a settings screen titled "Tracking by Speed". It has a dark background with white text. At the top, it says "Tracking by Speed". Below that, there are three sections: "Upper speed", "Lower speed", and "Tracking interval". The "Upper speed" section has a numeric input field with "0" inside, followed by the unit "km/h". The "Lower speed" section has a numeric input field with "0" inside, followed by the unit "km/h". The "Tracking interval" section is currently empty. At the bottom, there are two buttons: "Save" on the left and "Back" on the right.

For Time type, you can input from 3min up to 10 days for the frequency of outgoing messages.

The screenshot shows a settings screen titled "Tracking by Time". It has a dark background with white text. At the top, it says "Tracking by Time". Below that, there is one section: "Tracking interval". This section has three numeric input fields. The first has "00" inside, followed by "day(s)". The second has "00" inside, followed by "hour(s)". The third has "03" inside, followed by "minute(s)". Below these, it says "(3 mins to 10 days)". At the bottom, there are two buttons: "Save" on the left and "Back" on the right.

## Geofence

There are two types of geofencing available – Restricted zone and radio silence. You can set 10 polygons of 3 to 100 geo-coordinates respectively. Activate admin mode.



### NOTE

- Every Polygon entry once entered should be saved along with the area to avoid deletion of the entered data.
- Time interval for background checks is done every 15 minutes.

### 1. Restricted zone

This function will trigger alert tones on the terminal if you enter to the pre-defined restricted zone. The alert tones will stop if you exit the restricted zone. Terminal will send SMS when vessel moves in to or out of the pre-defined zone.

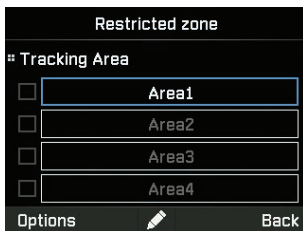

### 2. Radio Silence

This function will shut off the transmission of the terminal if you enter to the pre-defined radio silence zone. Transmission will be available if you are back in the allowed zone. And terminal will send SMS when vessel moves in or out of the pre-defined zone.

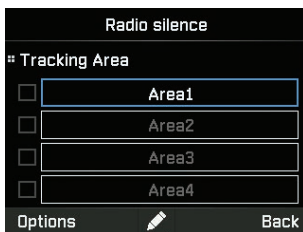



## Settings

You can set the list of tracking recipients (up to 5 – SMS/Email), defined the output format (Eg: Google format) as desired by the recipient and input the remote configuration server details/Short codes for third party tracking platform integrations. Access to this function is available in admin mode.

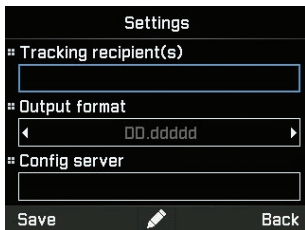

## Log list

The device saves up to 4000 events occurring and shows up to 20 events in the list under the tracking section. This can be viewed on the device and exported to a local device via RS-232 DB-9 serial interface. Access to this function is available in captain mode.

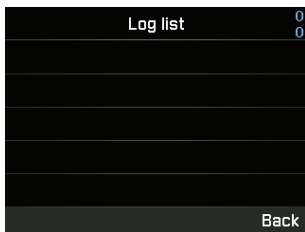

### NOTE

*Ensure to have the 3rd party terminal fully connected physically and with right configuration settings to the MNB-01 on the RS-232 serial port to avoid device hanging/corruption; The export operation could take few minutes depending on the number of events being transferred.*

# QUICK START GUIDE

## USING THE MNB-01

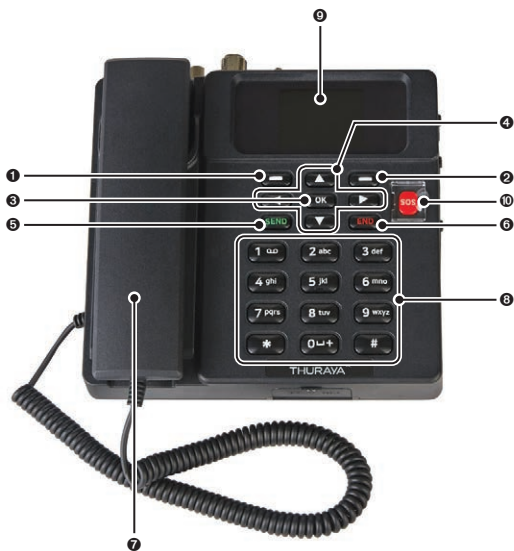

---

**1** Left Function Key

---

**2** Right Function Key

---

**3** Okay Key

---

**4** 4-Way Navigation Buttons

---

**5** Send Key

---

---

**6** End Key

---

**7** Handset (Ring tone speaker underneath)

---

**8** Keypad(Alpha-numeric)

---

**9** 2.4 inch 65K color TFT LCD Screen

---

**10** SOS Button

---



# GETTING STARTED

## Installing the SIM card

The Thuraya MNB-01 system requires a valid and active SIM card to access the satellite network and configure the settings of the Base Terminal.

Follow these steps to install the SIM card:

- 1 Unscrew the SIM card cover and flip it down.
- 2 With the SIM card's gold contact facing down, position the card as indicated and slide it into the slot.
- 3 Ensure that the SIM card is correctly inserted.
- 4 Close and fasten the screw of the SIM card cover.

## Power up the MNB-01

### Follow these steps to power up the MNB-01

- Tip the Power On/Off Switch on the left.



Power switch

- LED indicator to show green for successful input power. If it is flickering, then it is receiving either low voltage or high voltage.

## Basic Terminal Set Up

### ! NOTE







Before making a voice call, please make sure that:

- The SIM card is properly inserted in the SIM card slot.
- There should be at least 2 bars on the signal strength.



## Making / End a Voice Call

### ! NOTE

Before making a voice call, please make sure MNB-01 has registered the network and signal strength status indicator should be on (       ). There should be at least 2 bars on the signal strength.

To make a call from the Base Terminal, off-hook the handset cradle and dial.

+<country code><phone number> and press  key

or

00<country code> <phone number> and press  key

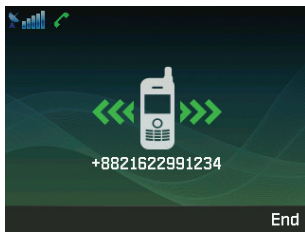

### ! NOTE

For voice calls in dial, you may also use '+' by pressing and holding the  key instead of "00" at the beginning of dialed number string as an alternative('+<country code> <phone number>).

To end the call, re-place the handset on the cradle.

To accept an incoming call, lift up the handset from the cradle.

## Receiving a call

When there is an incoming call, the MNB-01 terminal will:

- Ring
- The calling party's number will be displayed on the screen.  
The corresponding name of contact will be displayed if the number is stored in the contacts.

To answer an incoming call, pick up the handset from the cradle or from the analogue phone, if connected.

## Adjusting volume during a call

Use Left  / Right  Function Key adjust the volume.

# TROUBLESHOOTING

---

## Warnings

### Servicing

MNB-01 does not contain consumer serviceable components. You are advised not to carry out any kind of troubleshooting. In case you face any problems, contact the service center. Only authorized service personnel can repair the equipment.

### Antenna and RF cables

Use only MNB-01 antenna and RF cables that have been specifically designed for your terminal.

Unauthorized antennas, cables and cable length modifications, or attachments could damage the device and may violate the relevant regulations, causing loss or degradation of performance and radio frequency (RF) energy above the recommended limits. If your MNB-01 gets damaged, please take it to an authorized Service Partner.

### General

- Do not place MNB-01 in a wet area.
- Do not expose MNB-01 to temperatures greater than +55 °C or less than -15 °C.
- Do not expose MNB-01 to moisture, dust etc.
- Avoid placing MNB-01 close to open flames or any source of heat.
- Do not expose MNB-01 to direct sunlight.
- Do not disassemble MNB-01. This will void your warranty.

### Care and Maintenance

- MNB-01 is a product of superior design and craftsmanship and should be treated with care.
- The following suggestions will help you to fulfill any warranty obligations and allow you to enjoy this product for many years.
- Do not store it in hot areas.
- Do not attempt to open it. Mishandling of the device may damage it.
- Do not drop, apply pressure or shake it. Rough handling can break internal circuit boards.
- Do not use chemicals, cleaning solvents, or strong detergents to clean it. Wipe it smoothly with a soft cloth.
- Use only the supplied or approved replacement antenna.
- Ensure DC power supply connections are provided as per specs and do not swap + & - connections.

## 1 How to upgrade MNB-01?

The Base Terminal can be upgraded via the Serial port. Please download the latest firmware and upgrader from Thuraya website.

## 2 How to start and stop a GmPRS session?

Step 1. Connect the MNB-01 with the PC/Laptop via Serial data cable (RS-232 DB-9 cable).

Step 2. Create the dial-up connection of Windows for GmPRS as follows.

- Open **Settings** menu of Windows 10.

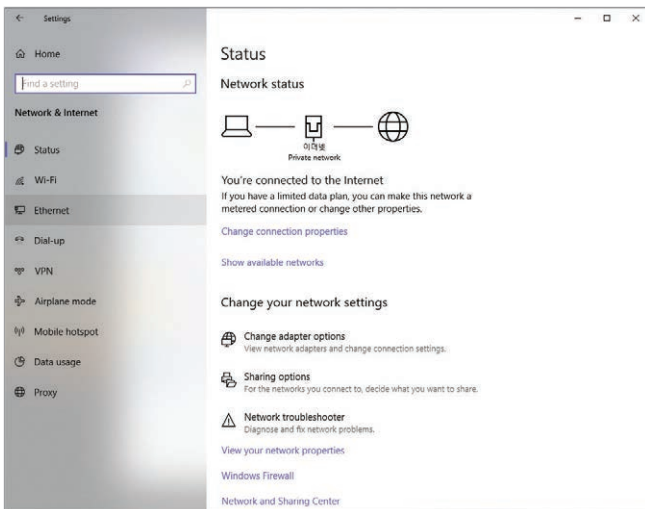

- Follow the steps below.

**Settings > Dial-up > Set up a new connection > Connect to the internet > Set up a new connection anyway > Dial-up > Set up a connection anyway**

The screenshot shows the 'Connect to the Internet' window in Windows. The title bar says 'Connect to the Internet'. Below the title bar, it says 'Type the information from your Internet service provider (ISP)'. There are several input fields: 'Dial-up phone number:' with the value '\*99#' and a 'Dialing Rules' link; 'User name:' with the placeholder '[Name your ISP gave you]'; 'Password:' with the placeholder '[Password your ISP gave you]', a 'Show characters' checkbox, and a 'Remember this password' checkbox; and 'Connection name:' with the value 'MarineStar'. At the bottom, there is a checkbox for 'Allow other people to use this connection' with the text 'This option allows anyone with access to this computer to use this connection.' and a link 'I don't have an ISP'. At the very bottom, there are 'Create' and 'Cancel' buttons.

- Enter Dial-up phone number '\*99#' and Connection name as 'MNB-01' or whatever you want and click 'Create' button.

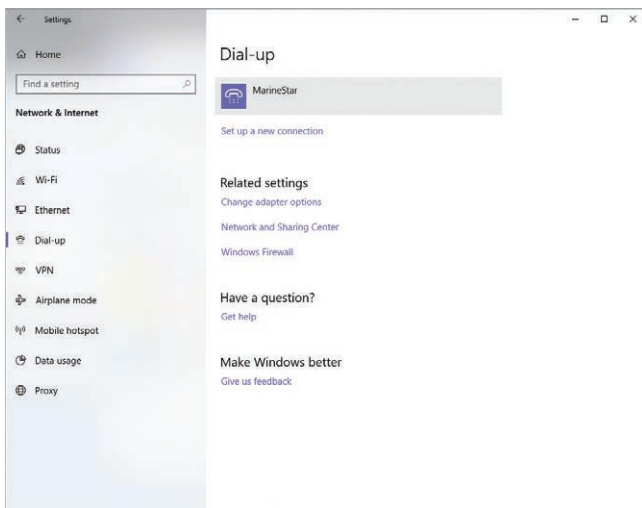

- You can find the MNB-01 dial-up connection icon in Dial-up menu.

Step 3. You can start GmPRS service by selecting the MNB-01 and you can stop GmPRS service by disconnecting dial-up connection in Windows.



#### **NOTE**

- For detailed information for Dial-up connection of Windows please refer to the Windows manual.
- For detailed information of APN please refer to the "**Settings**" in this manual.

### **3 How to use crew calling facility?**

Go to **Menu > Security > Crew calling** in admin mode to enable/disable the crew calling feature and set the short code.

In captain mode, only enable/disable the feature is possible.

When both of admin mode and captain mode are off, only short code numbers can be dialed if the crew calling is enabled.

### **4 How to transfer line from MNB-01 base terminal to an extension line connected to RJ-11 port and vice versa?**

Press #1 and off-hook the handset cradle for the transfer line.

### **5 What are the basic information needed by the supplier while reporting a fault?**

Date of Purchase, thuraya sim-card number/MSISDN, IMEI number and Serial number are needed.

### **6 How to extract device logs for maintenance?**

Go to **Menu > Location > Log list > Export log** in captain mode to extract the log via ZMODEM.

### **7 What is the difference between Radio silence, restricted zone and tracking by area?**

Radio silence is the function to shut off the transmission of the terminal if the device enters into the pre-defined zone.

Restricted zone is the function to trigger alert tones on the terminal if the device enters into the pre-defined zone.

Tracking by area is the function to send your coordinates to pre-defined numbers at regular intervals.

For the detailed information please refer to the "**Location**" in manual.

### **8 How can I integrate my own tracking & monitoring software platform with the MNB-01?**

Contact your service provider for further assistance.

# WARRANTY

---

This warranty table is only valid with all gaps fully filled by the dealer.

• **Date of Purchase:**

• **Customer's name, address, country and telephone number:**

• **Write the IMEI here:**

• **Dealer's stamp and signature:**



# MEMO

---



**THURAYA** 